

## **ARTICLE XI. SPECIAL PURPOSE ZONING DISTRICTS AND OVERLAY AREAS**

### **DIVISION 15: BRUSH PARK FORM-BASED DISTRICT**

#### **SEC. 61-11-401      PURPOSE**

The Brush Park Form-Based District is a subdivision of the Detroit Zoning Ordinance that focuses on the Brush Park neighborhood. The district is designed to provide residents and developers with a predictable vision of the built environment in Brush Park. The Form-Based Zoning District is intended to regulate land development using form as the primary component to define and codify the developing character of the neighborhood. The Form-Based Code creates opportunities for medium-density mixed-use development while incorporating elements from the Brush Park Rehabilitation Project Fourth Modified Development Plan and the Brush Park Historic District Design Guidelines. The Form Based District designates open space for community recreational use. Furthermore, the Form-Based Zoning District provides opportunities that promote the enhancement of the public realm, encourages pedestrian-friendly streets, and the advancement of a walkable urban neighborhood. The organizing principle for the Brush Park Form-Based District is based on a hierarchy of streets that designate the placement of specific building types and by-right uses based on intensity. The provisions set forth in this division shall repeal and replace all pre-existing regulations and serve as the terms of the underlying PD district.

#### **SEC. 61-11-402      INTENT**

The purpose of the Brush Park Form-Based District is:

1. To implement the goals and objectives of the City of Detroit master plan for the Brush Park neighborhood.
2. To provide the Brush Park community predictability in the outcome of development and redevelopment through an efficient administrative permitting process.
3. To provide a diversity of urban housing choices appropriate to Brush Park.
4. To place and permit commercial uses within a safe, comfortable walking distance of residential units.
5. To prevent the development of incompatible suburban development in Brush Park.
6. To encourage mixed-use development in order to reinforce Brush Park as a walkable urban neighborhood.
7. To designate the location of new public spaces to adequately provide recreational opportunities for the growing density of the neighborhood.
8. To designate new streets that align and are safe and secure for pedestrians and non-motorized transit.
9. To ensure that privately owned buildings, development, and land is cohesive with the public realm.
10. To permit the development of attached medium density residential buildings and multi-story, multi-unit, mixed-use buildings fronting John R and Brush Street.
11. To permit the development of medium density multi-unit detached, semi-detached, and attached residential buildings that relate to the size and scale of the existing historic district context on streets internal to the neighborhood.

#### **SEC. 61-11-403      APPLICABILITY**

- (a) The section is applicable to all real property within the Brush Park Form-Based District as shown on ARTICLE XVII District Map. No. 4 of the 1984 Detroit City Code, Chapter 61, Zoning and the Regulating Maps of Sec 61-11-407.
- (b) Where the provisions of this Division conflict with those found elsewhere in this Ordinance, the provisions of this Division apply.
- (c) When fifty percent (50%) of the total square footage or more a building or structure is altered, the building or structure shall be subject to the applicable dimensional requirements of this division as determined by City Planning Commission Staff and Planning and Development Department
- (d) When less than fifty percent (50%) of the total square footage of a building or structure is altered, the building or structure is subject to development review. The requirement is only that the proposed improvements meet the applicable standards of this subdivision.

Definitions

(e) Landscaping

Landscaping shall be in conformance with the provisions of ARTICLE XIV: DIVISION 2 LANDSCAPING, SCREENING AND FENCING of the Zoning Ordinance.

(f) Signage

1. Signage shall be in conformance with the dimensional provisions of ARTICLE VII of the 1984 Detroit City Code, Chapter 3, Regulation of Business Signs and ARTICLE VI of the 1984 Detroit City Code, Chapter 61, Signs.
2. All signage and graphics should be tastefully designed to be visually appealing, in character with surrounding development and should provide needed information, direction, and orientation in a clear and concise manner.
3. Signage shall be in accordance with the Brush Park Historic District Elements of Design.

**SEC. 61-11-404 DEFINITIONS**

Term	Definition
Basement	A space having one-half or more of its floor-to-ceiling height below the average level of the adjoining ground and with a floor-to-ceiling height of not less than seven (7) feet
Building Coverage	The portion of a lot that is covered by a building or structure, as measured from the outside of the building or structure at ground level, and expressed as a percentage of total site area
Civic Space	Land used as an outdoor recreation facility, as defined in <i>Sec. 61-16-144</i> of this Code.
Dooryard	A fenced or elevated garden or patio that buffers dwellings from the adjacent sidewalk.
Façade, Front	Any exterior wall of a building oriented in whole or in part toward a front lot line.
Façade Build Out	A ratio of building width to lot width, measured at the maximum front setback line. See Figure 409 (c).
Historic House	A principal building type built as a residential dwelling prior to 1940 and located within the Brush Park Historic District.
Lobby Entrance	An at-grade principal entrance providing access to upper story uses of a building.
Lot, Flag	A lot not fronting or abutting a public roadway and where access to the public roadway is limited to a narrow private right-of-way.
Lot, Key	A lot with a side lot line abutting the rear lot line of another lot.
Lot Line, Party	A side lot line shared between two attached and semi-detached Building Types.
Nonconformities	A “nonconforming use,” nonconforming structure,” or “nonconforming lot.” As found in the Detroit Zoning Ordinance <i>Sec. 61-16-143</i>
Nonconforming Lot	Lots or land parcels that were legally created but which no longer comply with the minimum area or width standards of the Brush Park Form-Based District.
Nonconforming Structure	Structures that were legally established but which no longer comply with the Intensity and Dimensional Standards in the Brush Park Form-Based District.
Nonconforming Use	Uses that were legally established but which do not appear in, or are specifically excluded from, the listings of uses permitted by-right in the Brush Park Form-Based District.
Porch	A roofed, raised platform, with a set of stairs, leading to an entrance of a building.
Portico	A roofed landing leading to an entrance of a building.
Principal Building	The building occupied or designed for the principal use. Specific types allowed in the Brush Park Form-Based District are Historic House, Mid-Rise Flats, Multiplex, and Townhouse.

Term	Definition
Principal Entrance	The main point of access for pedestrians into a building, upper story use, or ground floor tenant space.
Rear Building	A building oriented towards the alley. Specific types allowed in the Brush Park Form-Based District are Carriage House & Mews Building.
Stoop	An unroofed landing, with a set of stairs, leading to an entrance of a building.
Storefront	An at-grade portion of the front facade consisting of the principal entrance and substantial windows for the display of goods, services, and signs.
Story, Ground	The lowest story of a building with a finished floor at or above the established grade at the center of the front of the building.
Story, Upper	Any story above the ground story of a building.
Structured Parking	Motor vehicle parking spaces located within a building, whether above-ground or underground.
Visible Light Reflectance (VLR)	The percent of total visible light that is reflected by a glazing system. The lower the number, the less visible light reflected.
Visible Light Transmittance (VLT)	The percent of total visible light that is transmitted through a glazing system. The lower the number, the less visible light transmitted.

Development Review

**SEC. 61-11-405 DEVELOPMENT REVIEW**

**(a) Site Plan Review**

1. All development within the Brush Park Form-Based District requires Review for Consistency with the District in accordance with provisions of ARTICLE XI: DIVISION 2. PLANNED DEVELOPMENT DISTRICT of the Zoning Ordinance.
2. Within the Brush Park Form-Based District, City Planning Commission Staff and Planning and Development Department shall review and approve preliminary and final site plans, elevations, renderings, landscape and signage plans and must sign-off on construction drawings that are submitted to the Buildings, Safety, Engineering Environmental Department for applicant to be eligible to pull permits. Applications for site plan review shall be obtained from and submitted to City Planning Commission Staff to be reviewed, and approved for applicable developments. City Planning Commission Staff and Planning and Development Department shall review submitted application and plans to determine if plans conform to the provisions of this Division. All final construction drawings, site plans, lighting, signage, and elevations must be approved and signed-off by City Planning Commission Staff prior to application for building permits.
3. The Water and Sewerage Department is authorized to participate in the review of all site plans in order to advise on a post-construction stormwater management plans.

**(b) Historic Review**

1. Any development located within the City of Detroit designated Brush Park Historic District identified in Chapter 25 of City Code requires review and approval by the City of Detroit Historic District Commission. See *Sec. 61-2-151* for more information.
2. The Brush Park Historic District along with the boundary of the Brush Park Form-Based District are shown on Map 407 (b) for reference.

**(c) Administrative Adjustments**

Up to fifteen percent (15%) modification of any numeric standard that is set forth in accordance with this division may be permitted if authorized by City Planning Commission Staff and Planning and Development Department.

**(d) Variances**

Land use variances are not permitted.

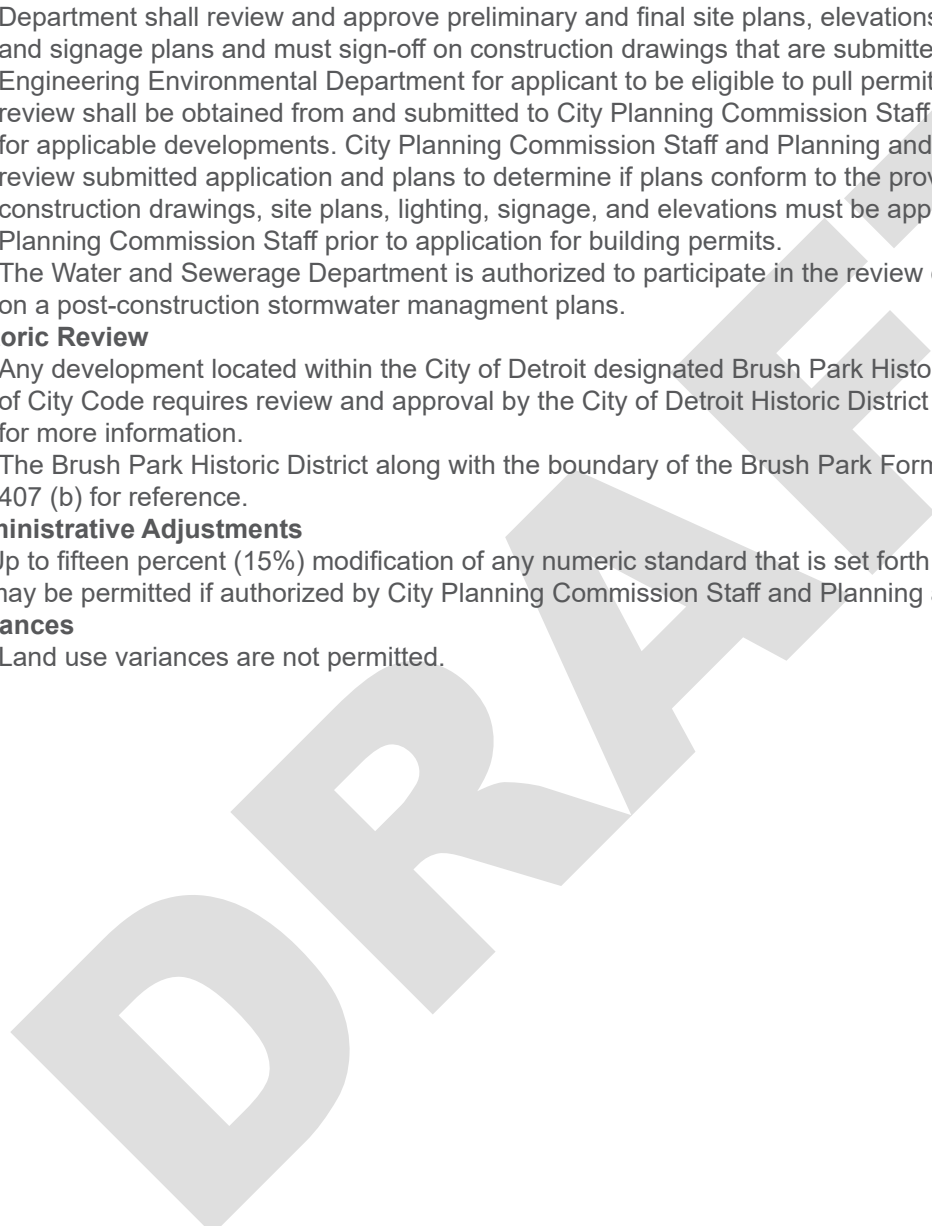

**FIGURE 405 Brush Park Permitting Process Diagram**

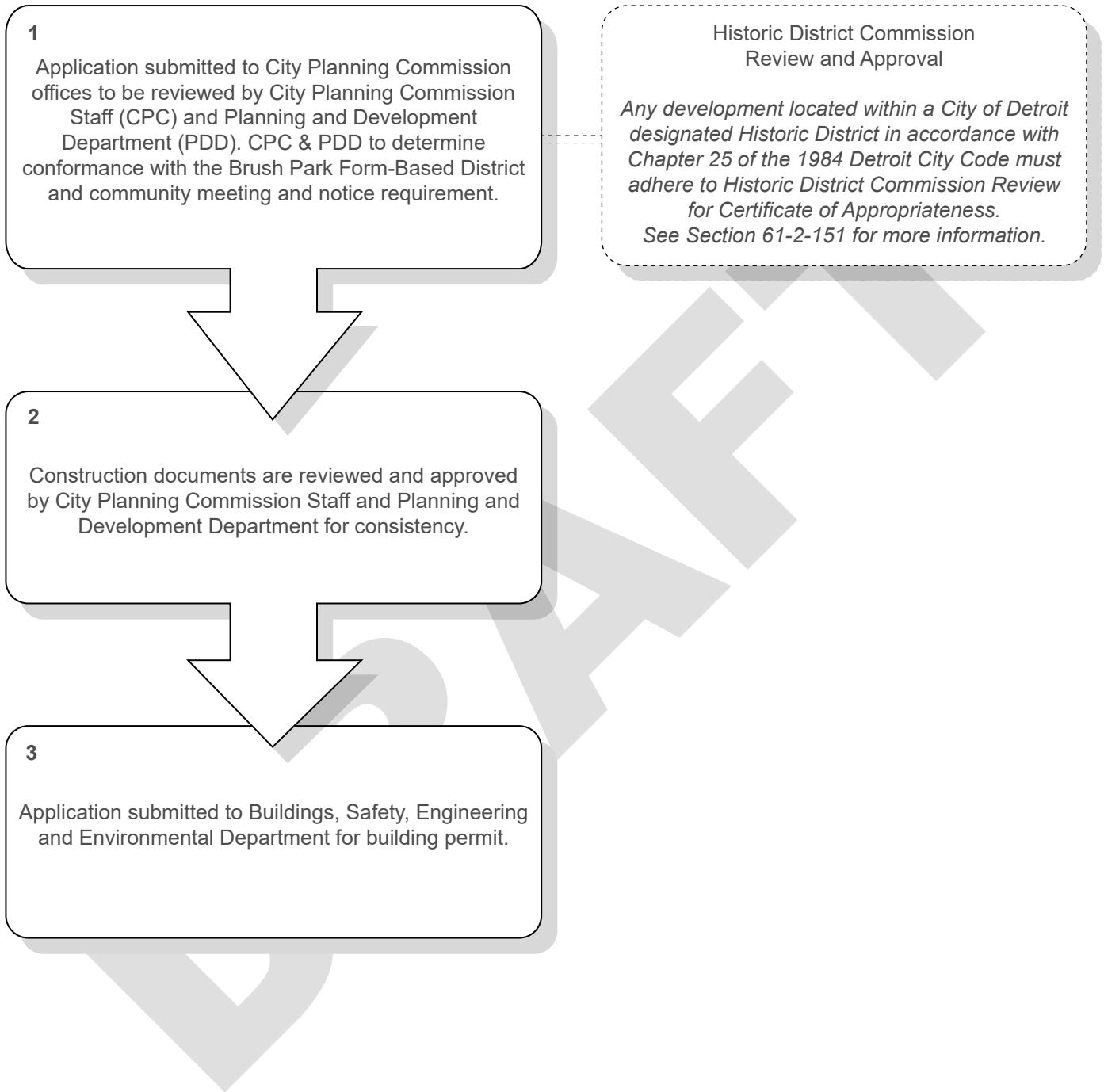

Nonconformities

**SEC. 61-11-406 NONCONFORMITIES**

**(a) General**

1. The adoption of the Brush Park Form-Based Zoning District may cause previously lawful conforming structures, lot characteristics, or uses to become nonconforming.
2. The regulations of this section govern nonconforming uses, nonconforming structures, nonconforming lots, and other nonconformities that came into existence legally but do not comply with one (1) or more requirements of the Brush Park Form-Based District.
3. The regulations of this section apply to all nonconforming elements of a structure, lot, sign or building.

**(b) Authority to Continue**

Any nonconformity that legally existed at the time of adoption of this Brush Park Form-Based District or that becomes nonconforming upon the adoption of any amendment to this zoning ordinance may be continued only in accordance with the provisions of this section.

**(c) Determination Status**

1. A structure, lot, use or site characteristic that existed prior to the establishment of the Brush Park Form-Based District when platted, built or established and remains in compliance with subsequent amendments to the Detroit Zoning Ordinance, is legally nonconforming. A structure, lot, use, or site characteristic that existed prior to the establishment of the Brush Park Form-Based District or that was in compliance with the code when platted, built or established but has become non-compliant due to this ordinance or a subsequent amendment to this ordinance is a pre-existing legal-nonconformity.
2. The burden of proving that a structure, lot, use or site characteristic is a preexisting nonconformity is solely the responsibility of the property owner.
3. Applicants applying for development review required by this Division may be required to submit evidence of a prior permit or other supporting documentation showing that the structure, lot, use or site characteristic was legally platted, built or established prior to the adoption of this ordinance or any subsequent amendment.
4. The reviewing staff of the City Planning Commission and Planning and Development Department shall determine whether the evidence provided suitably establishes the pre-existing nonconformity status for the subject property.

**(d) Basic Rights**

1. Pre-existing nonconforming structures, lots, uses, or site characteristics may continue in the same form and intensity so long as the nonconformity remains unchanged.
2. Status as a preexisting nonconformity is not affected by changes in tenancy, ownership or management.

**(e) Nonconforming Lots**

1. Buildable Lots  
Any vacant lot with dimensions that meet the lot standards for any permitted building type in the zoning district is considered a buildable lot.
2. A lot split, lot combination, or lot line adjustment, or subdivision that would result in a new nonconformity is prohibited.

**(f) Nonconforming structures**

1. Ordinary repair and maintenance of a nonconforming structure including, but not limited to painting roof replacement, re-siding, window replacement, and other improvements that are deemed to be cosmetic or minimal in nature by City Planning Commission Staff and the Planning and Development Department are permitted but must be reviewed and approved by the Historic District Commission.
2. Any modification that increases an existing nonconformity or creates a new nonconformity is prohibited.
3. Any modification that results in greater conformance to this ordinance is permitted.

**(g) Nonconforming Uses**

1. Change of Use
  - a. A nonconforming use may change to a conforming use as indicated in Table 413 as long as it complies to the regulating plan set forth in this Division.
  - b. A nonconforming use may not change to another nonconforming use but must comply with the allowable uses in Table 413.

**(h) Nonconforming Site Characteristics**

1. Nonconforming site characteristics, including parking, should not cause structures or uses that are otherwise conforming to the provisions of this ordinance to become nonconforming.
2. Alterations

City Planning Commission Staff and Planning and Development Department may require nonconforming site characteristics to be brought into conformance with the provisions of this ordinance as a condition applied to an approval.

**(i) Casualty**

1. Where legal-nonconforming real property is destroyed to the extent that more than sixty percent (60%) of the assessed valuation of the structure at the time the damage occurred, the structure shall not be re-established, except in compliance with all applicable Use Regulations, Intensity and Dimensional Standards, and General Development Standards.
2. In instances where less than sixty percent (60%) of the assessed valuation, the property can be reconstructed or restored and requires review in accordance with and subject to the following:
  - a. The cause of destruction was not the deliberate action of persons with legal interests in the property or its agents.
  - b. There shall be no alteration to the degree of nonconformity from the state existing prior to damage.
  - c. Reconstruction or restoration shall be started within a period of two (2) years of the date of damage and shall be continued until completion. City Planning Commission Staff and Planning and Development Department may consider an extension completion after a two (2) year lapse.
  - d. No building permit shall be issued until final site plans and elevations have been reviewed and approved by City Planning Commission Staff and Planning and Development Department.

**(j) Abandonment**

Lawfully existing nonconforming property is considered abandoned pursuant to the standards of *Section 61-15-21*.

Regulating Maps

**SEC. 61-11-407 REGULATING MAPS**

**(a) District Boundary**

The boundary of the Brush Park Form-Based District is shown on Maps 407 (b) and Map 407 (c).

**(b) Street Type Frontage Map**

1. Streets are classified as different by type and identified by letter on Map 407 (b).
2. Principal and rear building types are permitted as specified on Table 407 (a) based on the street type frontage of each lot.
3. For any lot on B and C street types where either of the two abutting lots have a historic house principal building type, the Multiplex is the only permissible principal building type.
4. Principal and rear building types are subject to the standards for each type in Section 61-11-412.

**TABLE 407 (a) Permitted Building Types**

	A Street	B Street	C Street	Type Specific Standards
<b>Principal Buildings</b>				
Historic House	n/a	n/a	n/a	Sec. 61-11-412 (c)
Multiplex	N	P	P	Sec. 61-11-412 (d)
Townhouses	P	P	P	Sec. 61-11-412 (e)
Mid-Rise Flats	P	P	N	Sec. 61-11-412 (f)
<b>Rear Buildings</b>				
Carriage House	P	P	P	Sec. 61-11-412 (g)
Mews Building	P	P	P	Sec. 61-11-412 (h)

P - Permitted                      N - Not Permitted

**(c) New Streets and Civic Spaces Map**

1. New streets and civic spaces shown on Map 407 (c) New Streets and Civic Spaces Map are mandatory.
2. The establishment of streets not shown on the Brush Park Streets and Civic Spaces Map is prohibited.

**(d) Map Changes**

Changes to Map 407 (b) and Map 407 (c) require Text Amendment in accordance with the provisions of ARTICLE III of the 1984 Detroit City Code, Chapter 61, Zoning.



MAP 407 (b) Street Type Frontage Map

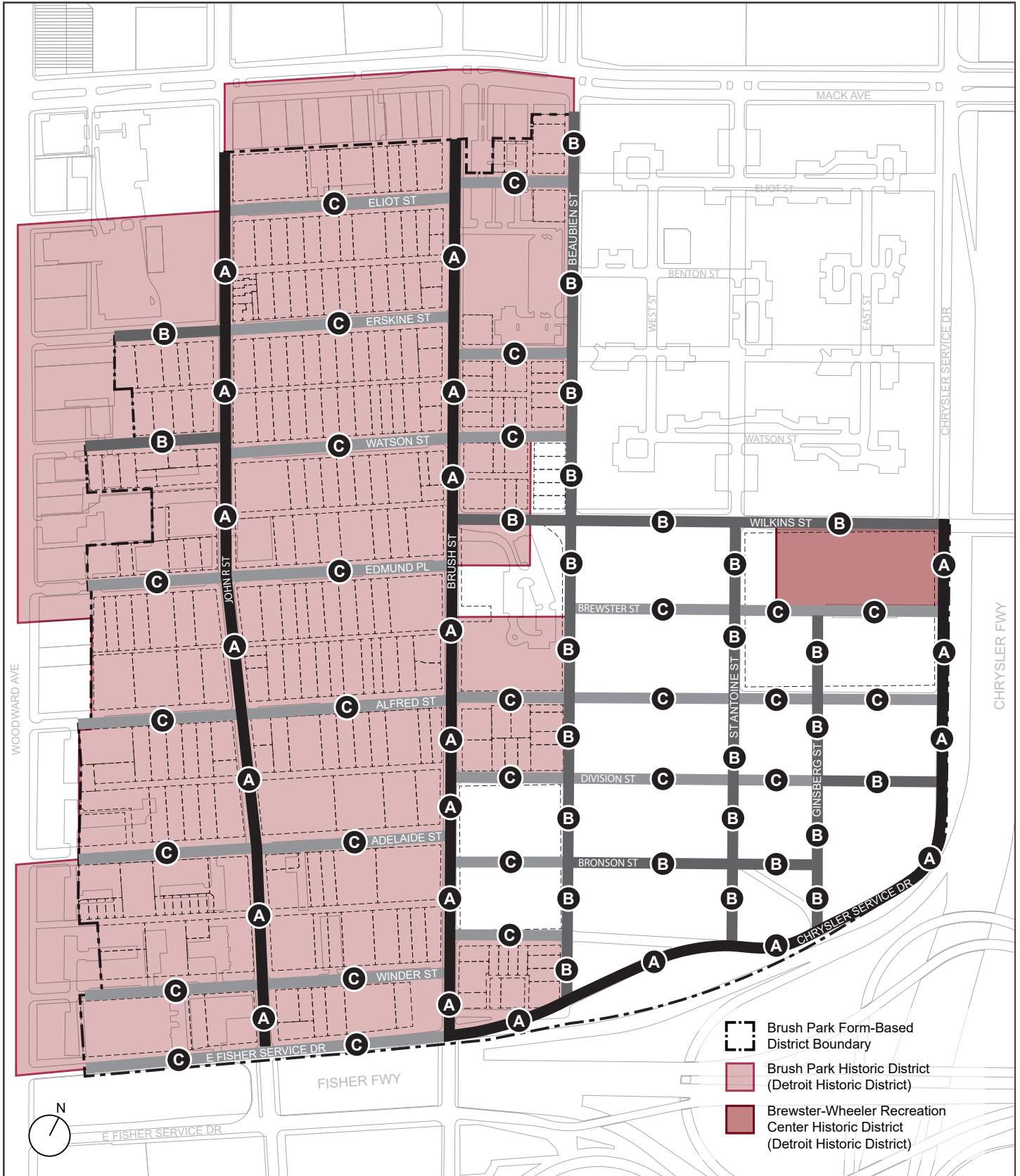

Regulating Maps

MAP 407 (c) New Streets and Civic Spaces



**DRAFT**

This page intentionally left blank

**SEC. 61-11-408 PUBLIC REALM STANDARDS**

**(a) General**

This Section regulates the design and construction standards for the public rights of way to ensure that privately owned land is cohesive with the public realm.

**(b) Streets**

1. New streets must be provided as shown on Map 407 (c).
2. New streets must be designed in accordance with the standards of Figure 408 (c) Neighborhood Street.
3. All new and reconstructed sidewalks must be accessible to and usable by persons with disabilities in accordance with the Americans with Disabilities Act, as amended.
4. The pavement design of walkways must be continuous for the full length of each block.
5. Street trees are required for all new streets.
6. Any new development with a planting strip of a minimum of four (4) feet must provide street trees consistent with Figure 408 (c) Neighborhood Street and *Section 61-14-204 Prohibited Tree Species*.
7. Street trees must be at least ten (10) feet in height or three (3) inches in caliper when planted, unless alternative, multi-stemmed equivalents are specified in the approved planting plan.
8. Street trees must be planted flush-to-grade or at grade within planting beds.
9. Tree pits and planters must have a minimum twenty-four (24) square foot (such as 4'x6') open soil area, centered at the tree trunk. Planting soil must be provided to a depth of three (3) feet in the tree pit or planter. Shredded bark mulch must be applied to the soil area at a uniform depth of three (3) inches and distributed to create a smooth, level cover over the exposed soil at the time of planting.
10. If included, sidewalk extensions must occupy the full width of the parking lane they extend into.
11. When a bike lane is present, sidewalk extensions must be set back so that the gutter does not extend into the bike lane.
12. At corners, sidewalk extensions must run at least five (5) feet from the corner area of the sidewalk as shown in Figure 408 (a).
13. Curb cuts may be no wider than the driveway or vehicular entrance they serve, excluding flares or returned curbs.
14. Driveway and alley crossings must maintain the grade, width, and paving of the sidewalk they cross.
  - a. Crossings traversing fully paved sidewalks must include sloped flares on either side of the driveway apron.
  - b. Driveway crossings traversing sidewalks with landscape planters must include returned curbs.
15. The appearance of any walkway (ie. scoring pattern or special paving) must be maintained across any driveway or alley to indicate that, although a vehicle may cross, the area traversed by a vehicle remains part of the sidewalk.

**FIGURE 408 (a) Sidewalk Extensions**

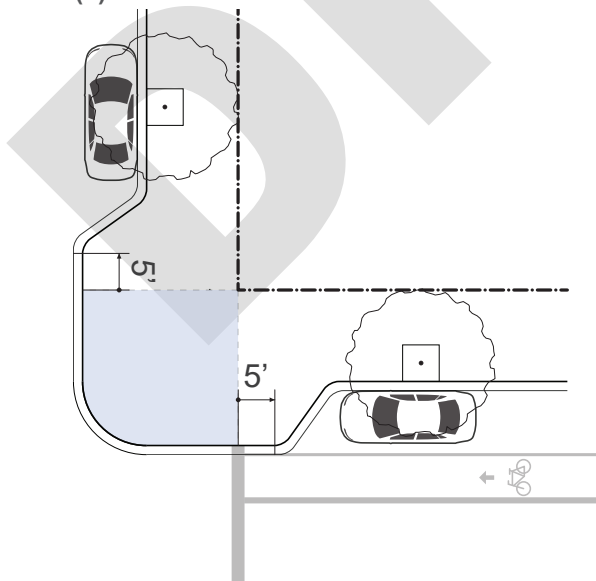

**FIGURE 408 (b) Driveway and Alley Crossings**

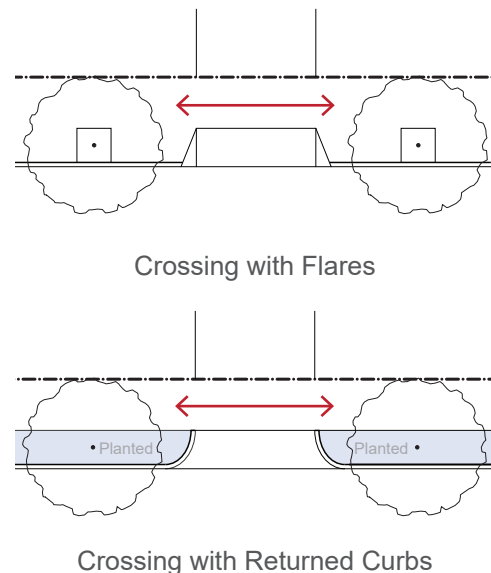

16. All street construction and maintenance must comply with City and industry standards pursuant to Chapter 50: Streets, Sidewalks, and other Public Places.

17. A mid-block pedestrian crossing may be provided for civic space access.

**(c) Civic Space**

Preserved and new civic space must be provided as shown on Map 407 (c).

a. Civic Space A must be at least 44,000 square feet and must be developed as a new park. Park siting may be altered with City Planning Commission Staff and Planning and Development Department approval but, must maintain at least 44,000 square feet in total.

b. Civic Space B must be at least 7,500 square feet and must be an expansion of the John R Watson Park.

**Figure 408 (c) Neighborhood Street**

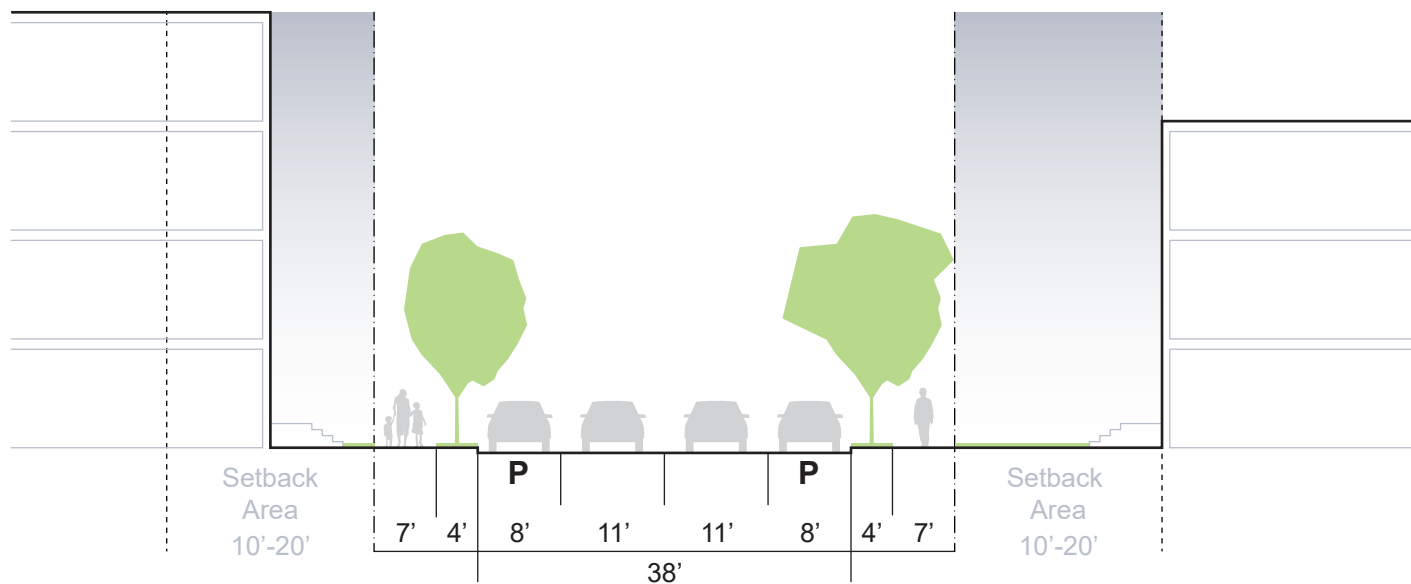

Right of Way	
Street Type	B & C Street
Total Width	60' min
Pavement Width	38' max
Movement	Two-Way
Driveway Access	Permitted

Roadway	
Travel Lanes	2 max
Travel Lane Width	11' max
Parking Lanes	2 max
Parking Lane Width	8' max
Parking Type	Parallel
Drainage Type	Raised Curb

Sidewalk	
Total Width	11' min
Furnishing Zone Width	4' min
Walkway Width	7' min
Street Tree Planting Technique	Continuous Planter or 24 sf. Tree Pit
Street Tree Spacing	20' - 30' on center (avg.)
Public Lighting Spacing	40' - 60' on center (avg.)
Crosswalk Type	Continental
Curb Radius	10' max
Traffic Calming	Sidewalk Extensions

**SEC. 61-11-409 DEVELOPMENT STANDARDS**

**(a) General**

This Section sets forth the standards for each building type listed in Table 407 (a), defines how to measure each requirement, and provides other standards and reference information as necessary.

**(b) Lot Standards**

1. Up to one (1) principal building and one (1) rear building type may be built on each lot.
  - a. Principal buildings must be compliant with ARTICLE XII: DIVISION 4 PRINCIPAL USES AND STRUCTURES of this Ordinance.
2. Lots must be configured as a corner, interior, or key lot in accordance with *Section 61-14-268 (2)* of this Division. Flag lots and through lots are prohibited.
3. Any lot line abutting an A street is a primary front lot line.
4. The front lot line of any interior lot or key lot is a primary front lot line.
5. For corner lots, the primary front lot line is designated as follows:
  - a. Any lot line abutting an A street is a primary front lot line.
  - b. For all other corner lots, the primary front lot line is designated by the property owner, with all remaining front lot lines designated as secondary front lot lines.
6. Lots must have a lot width appropriate for one or more permitted building type(s).
7. Lot width is measured at right angles to the lot depth at points twenty (20) feet from the front lot line and twenty (20) feet from the rear lot line.
8. Lot depth is measured as the horizontal distance between the midpoint of the primary front lot line and the midpoint of the rear lot line or to the most distant point on any other lot line where there is no rear lot line.

**(c) Building Placement**

1. Unless otherwise specified in this Section, all buildings and structures must be located at or behind any required minimum front, side, or rear setback.
2. The facade of a principal building must be built at or in front of any maximum front setback for each story of a building.
3. All development on any lot abutting the Chrysler Service Road must be setback an additional twenty five (25) feet to accommodate a landscaped buffer from the highway. The minimum and maximum front setbacks for each building type are increased accordingly.
4. Notwithstanding the front setbacks identified for each principal building type, new development must have a contextual front setback as follows:
  - a. If the subject lot is an interior lot or key lot, the minimum and maximum front setbacks are equal to the actual distances that principal structures are setback from the front lot line on the two abutting lots of the same block

**FIGURE 409 (a) Lot Dimensions**

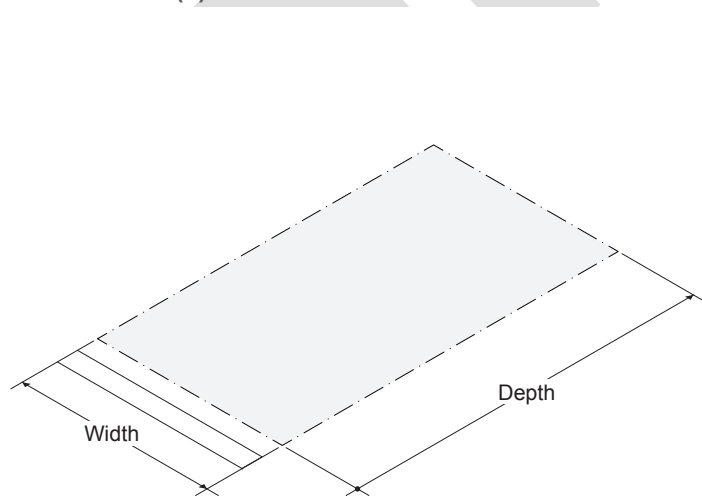

**FIGURE 409 (b) Setbacks**

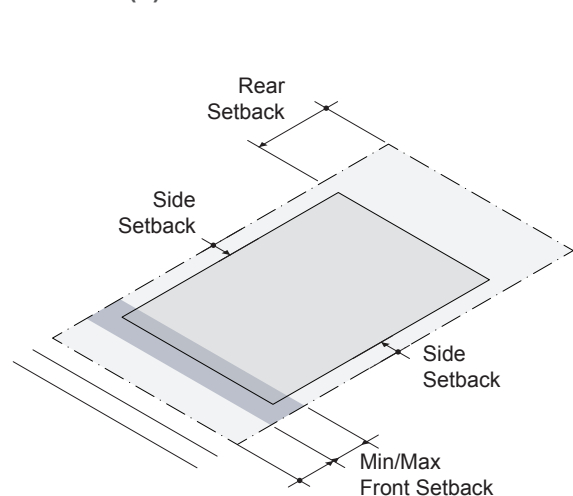

face.

- b. If the subject lot is a corner lot, the minimum front setback is equal to the actual distance that the principal structure is setback from the front lot line on the abutting lot that is oriented toward the same street for the appropriate primary frontage.
  - c. If the lot on either side of the subject lot is vacant, the minimum and maximum front setback identified for each building type governs.
5. The contextual front setback provision does not exempt any building from complying with the maximum front setback required for each building type.
  6. Stoops, porticos, porches, awnings, and entry canopies may encroach into any required front setback.
  7. Cornices, belt courses, sills, buttresses and other architectural features may encroach up to two (2) feet into any required setback.
  8. Chimneys may encroach up to four (4) feet into any required setback, provided that at least two (2) feet is maintained from the vertical plane of any lot line.
  9. Building eaves and roof overhangs may encroach up to three (3) feet into any required setback, provided that at least two (2) feet of setback is maintained from the vertical plane of any lot line.
  10. Unenclosed fire escapes or emergency egress stairways may encroach up to four (4) feet into any required side or rear setback, provided that at least two (2) feet of setback is maintained from the vertical plane of any lot line.
  11. Mechanical equipment associated with residential uses, such as HVAC units and security lighting, may encroach into a required side or rear setback, provided that at least two (2) feet is maintained from the vertical plane of any lot line.
  12. Terraces, uncovered and unenclosed patios, and structures below and covered by the ground may fully encroach into a required setback.
  13. Minor structures accessory to utilities, such as hydrants, manholes, transformers, and other cabinet structures, may fully encroach into a required setback.

#### (d) Building Standards

1. The facade of a principal building must be built parallel to the front lot line or to the tangent of a curved front lot line.
2. The façade of a building must be built to the façade build-out ratio specified for each building type.
3. Building width is measured parallel to the facade of a building, from the exterior of each side wall.
4. Building depth is measured perpendicularly from the facade as the maximum length of any exterior side wall of a building.
5. The total number of stories of a building is calculated as follows:
  - a. The ground story is counted as one (1) story, except that a single ground story of twenty-five (25) feet or more is counted as two (2) stories.
  - b. Each upper story is counted as one (1) additional story, except that any story, excluding the ground story, with a mezzanine or loft is counted as two (2) stories.
  - c. Interstitial space between stories is counted as an additional story if the space has a walking surface, permanent lighting, a ceiling height of seven feet six inches (7'6") or more, or is accessed via a stairwell or elevator door.
  - d. Basements are counted as one (1) story only when the finished floor of the ground story is five (5) feet or more above the established grade at the center of the front of the building.
6. Any new structure immediately adjacent to an existing historic house is allowed a maximum of four (4) stories or must provide a fifth story step back with a minimum of fifty-five (55) feet from the front facade of the abutting building.

FIGURE 409 (c) Facade Build-Out

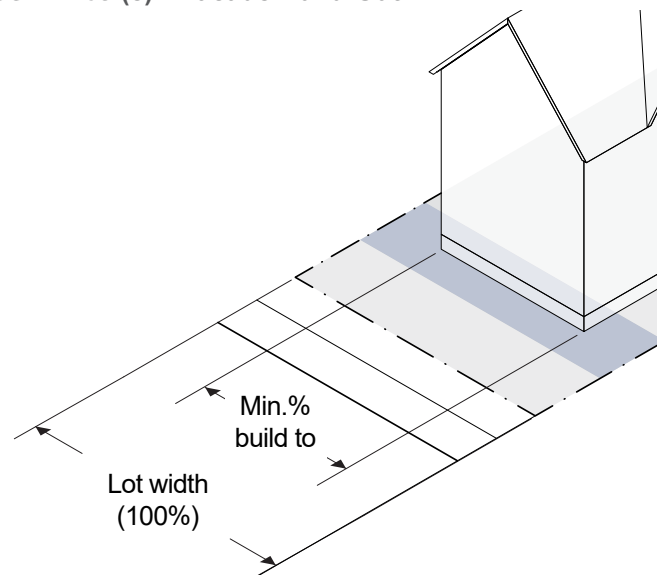



Development Standards

7. For the area bounded by Beaubien Street, Bronson Street, Ginsberg Street, Alfred Street and the Chrysler Service Drive, in accordance with Map 407 (b), the maximum number of stories allowed is fifteen (15) stories.
8. Story height is measured vertically from the surface of the finished floor to the surface of the finished floor above. When there is no floor above, story height is measured from the surface of the finished floor to the top of the structural beam or joists above or the top of the wall plate, whichever is more.
9. Minimum story height requirements are not measured for half-stories.
10. Ground story elevation is measured from the average grade of the sidewalk of the abutting street or from the crown of the roadway of the adjacent street when no sidewalk exists, to the top of the finished floor of the ground story of a building.
11. The height of a building is the vertical distance from the grade plane at the center of the front of the building to the highest point of the structure, for a flat roof or mansard roof, and too the mean height level (midpoint) between eaves and ridge for gables, hip, and gambrel roof.
12. Roof decks, mechanical & stairwell penthouses, roof mounted cellular, radio, and internet transmission equipment; vents or exhausts; solar panels or skylights; flagpoles; belfries, chimneys, cupolas, monuments, parapets, spires, steeples, and other non-habitable architectural features are permitted on roofs and do not count towards the building height.
13. Principal entrances must be located on the front facade of a building, provide both ingress and egress, and be operable at all times.
14. Access to principal entrances for residential uses must be provided by way of a stoop, portico, porch, dooryard, or lobby entrance.
15. Principal entrances must include an awning or entry canopy, except in circumstances where the principal entrance is recessed into the facade of the building. Awnings and entry canopies must be equal to or greater than the width of the doorway surround, trim, or exterior casing it is mounted above; at least three (3) feet in depth; and provide at least eight (8) feet of clearance.
16. Fenestration must be provided as indicated for each building type and is calculated as a percentage of the total area of a facade, measured for each story independently.
  - a. Ground story fenestration is measured between two (2) feet and twelve (12) feet above the abutting sidewalk.
  - b. Upper story fenestration is measured from the top of a finished floor to the top of the finished floor above.
17. Glazing must meet the following criteria:
  - a. For ground story fenestration, glazing must have a minimum of 60% Visible Light Transmittance and no more than 15% Visible Light Reflectance. Ground floor commercial storefront glazing must remain unobstructed up to a minimum depth of five feet, with the exception of obstructions such as window signs or product displays that do not take up more than 25% of the total window area.
  - b. For upper story fenestration, glazing must have must have a minimum of 40% Visible Light Transmittance and no more than 15% Visible Light Reflectance.
18. Blank wall area is any portion of a facade that does not include fenestration or surface relief through the use of columns, cornices, moldings, piers, pilasters, sills, sign bands, other equivalent architectural features that either recess or project from the average plane of the facade by at least four (4) inches.
19. Blank wall area limitations apply both vertically and horizontally for all stories of a building for any facade.
20. Where required, outdoor amenity space must be provided for each dwelling unit as a balcony, deck, patio, porch, roof deck, roof terrace, or yard.
21. Each outdoor amenity space must provide at least thirty-six (36) square feet of unobstructed seating area, with no dimension less than four (4) feet.

**FIGURE 409 (d) Building Stories**

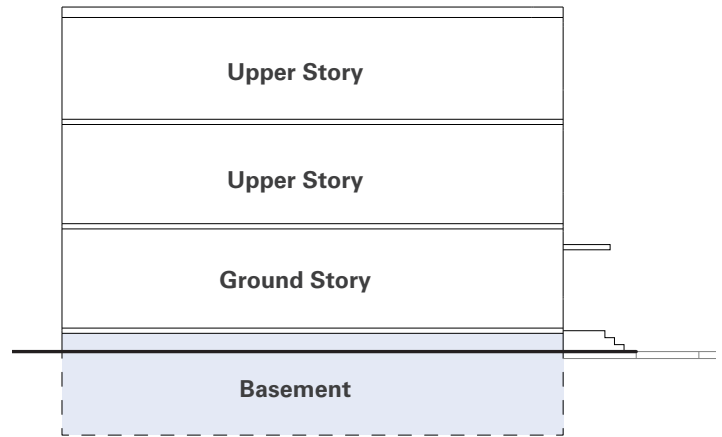
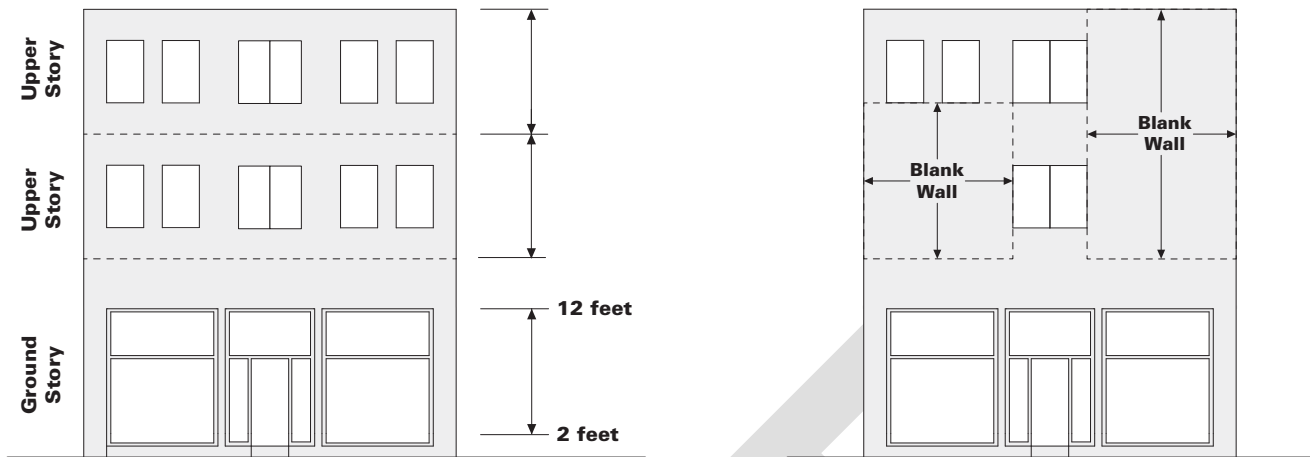



FIGURE 409 (e) Fenestration



22. All building types may provide shared outdoor amenity space, provided that the shared space provided includes the combined seating area required for each dwelling unit that the shared space is meant to serve.
23. Ground story dwelling units must be at least twenty (20) feet in depth, measured as the distance from the facade towards the interior of the building.

## SEC. 61-11-410 ACCESS/PARKING

### (a) General

This Section gives provision for all permitted forms of accessory parking and access to that parking; also gives provision for shared parking and additional circumstances.

- (b) No additional off-street parking, beyond that already provided, shall be required for structures that do not exceed three thousand (3,000) square feet of gross floor area.
- (c) For structures over three thousand (3,000) square feet, City Planning Commission Staff and Planning and Development Department may grant a waiver of the off-street parking requirements for the first three thousand (3,000) square feet of pedestrian-oriented retail, service, or commercial uses. City Planning Commission Staff and Planning and Development Department shall have authority to consider such waiver, ensuring that the waiver will not be injurious to the adjacent or surrounding areas by creating or increasing traffic congestion or by disrupting traffic circulation. In the case where one building or development contains multiple retail, service, or commercial uses, the total number of spaces that may be waived for a building or development using this waiver shall not exceed forty five (45) spaces
- (d) Unless otherwise specified, all off-street parking, including surface and structured parking, but excluding underground parking, must be located at or behind any required parking setback. Notwithstanding Sec. 61-14-222. Residential Screening Section 1 (b), the nearest parking space, drive aisle, or other paved surface within a parking area must be located at least six (6) feet from any abutting residential lot.
- (e) Motor vehicle parking may be provided as surface parking spaces, above ground structured parking, and underground structured parking.
- (f) Motor vehicle parking, excluding any required handicapped parking, may be provided within one thousand three hundred and twenty (1,320) feet in walking distance to the lot it will serve, measured in radial feet from the nearest point of the off-site parking;
  1. Pedestrian access to off-site motor vehicle parking must be via a paved sidewalk or walkway.
  2. A lease, recorded covenant, or other comparable legal instrument guaranteeing long term use of the site must be provided during site plan review and filed with City Planning Commission Staff and Planning and Development Department.
- (g) Motor vehicle parking must have direct access to a street via a driveway, alley, or a vehicular entrance into a building.

Perimeter Definition/Fencing

- (h) Motor vehicle parking, loading docks, and service areas must be accessed from an alley or across a secondary front lot line. Access to motor vehicle parking from a primary front lot line is prohibited.
- (i) Vehicular entrances to parking lots and parking structures must be no wider than twenty four (24) feet.
- (j) Driveways must be not wider than twelve (12) feet.
- (k) Curb cuts must be no wider than the driveway or vehicular entrance they serve, excluding flares or returned curbs.
- (l) Driveways may be located within a required side and rear setback area, but are not permitted between the facade of a building and any front lot line.
- (m) Driveways may provide access in whole or in part on or across an abutting lot(s), provided that an access easement exists between all property owners.
- (n) Curb cuts must be located to minimize conflict with pedestrians, bicyclists, and motor vehicles using the abutting street.
- (o) Where a proposed land use is not reasonably able to accommodate required parking spaces due to lot dimensional capacity, City Planning Commission Staff and Planning Development Department may review and consider a submitted shared parking plan and authorize a reduction and/or authorize that the required parking spaces be provided on a lot that is accessory to a separate land use. Shared parking shall be subject to the following standards:
  1. Eligibility: The subject shared parking lot shall accommodate the parking space ratio required for its principal use and have additional spaces and/or have different peak parking demands or different operating hours than shared use.
  2. Location: Shared off-street parking spaces shall be located within one thousand three hundred and twenty (1,320) feet of the principal land use.
  3. Required Study and Analysis: The applicant shall submit a shared parking analysis to City Planning Commission Staff and Planning and Development Department clearly demonstrating the feasibility of shared parking. At a minimum, the study shall address the size and type of the proposed development, the composition of tenants, the anticipated rate of parking turnover and the anticipated peak parking and traffic loads for all uses that will be sharing off-street parking spaces; and
  4. Shared Parking Agreement: A shared parking plan, that is duly recorded, as specified in *Sec. 61-14-106* of this Code, shall be enforced through written agreement, which consists of a permanent property easement, lease, or memorandum of lease among the owners of record. A traffic study may also be requested if deemed necessary to evaluate impact on adjacent properties. The agreement shall specify that the shared parking agreement may be revoked by the parties to the agreement only where off-street parking is provided pursuant to (section where parking chart/requirements are located) or where another Alternative Parking Plan is approved.
- (p) Legally permitted on-street parking spaces that are 23 feet long and immediately adjacent to the development parcel may be counted toward the off-street parking requirement.

FIGURE 410 (a) Parking Setbacks

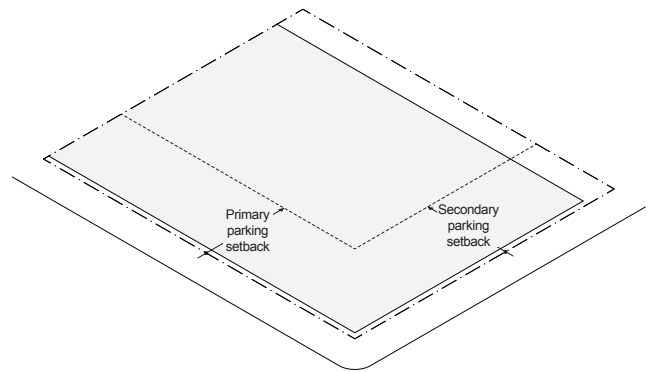

**SEC. 61-11-411 PERIMETER DEFINITION/FENCING**

- (a) Parking lots visible from any front lot line of the same lot must be effectively screened by a perimeter wall or fence.
- (b) Perimeter walls and fences must be no more than four (4) feet in height measured from the surface of the lot, no less than fifty percent (50%) opaque, and designed to allow surveillance over and beyond the wall or fence by pedestrians approaching or passing the parking lot.
- (c) A fence or hedge row may be placed along lot lines to define the perimeter of each lot as indicated for each building type. Chain link fences are prohibited.
- (d) Fence posts or supporting rails must face inward toward the property being fenced and the finished face must be oriented towards the adjacent property.
- (e) Fences located forward of any maximum primary or secondary front setback may be a maximum of four (4) feet in

height and no more than fifty percent (50%) opaque.

- (f) Fences located behind any maximum front setback, internal to the lot, may be a maximum of six (6) feet in height and fully opaque.

**SEC. 61-11-412 PRINCIPAL AND REAR BUILDING TYPES**

**TABLE 412 (a) Principal Building Types and Example Variations**

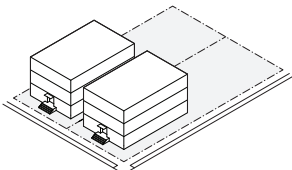
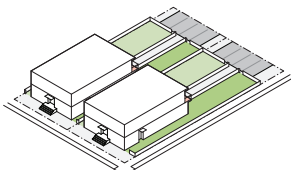
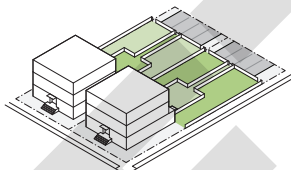
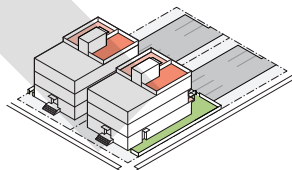
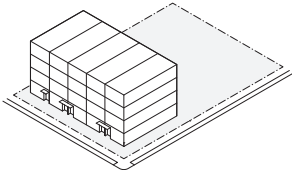
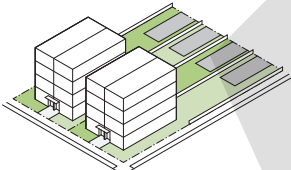
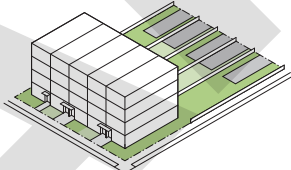
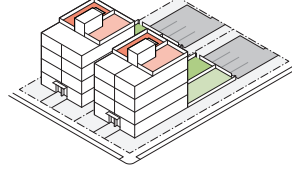
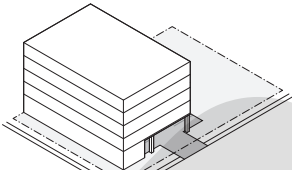
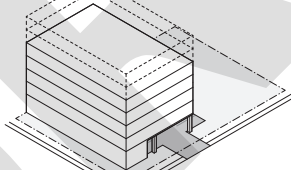
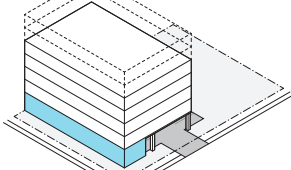
Principal Building Types	Example Variations		
<b>Multiplex</b>	Duplex	Triplex	Sixplex
			
<b>Townhouses</b>	Side by Side Townhouses	Townhouses	Stacked Townhouses
			
<b>Mid-Rise Flats</b>	Apartment Building	Mixed-use Building	
			

**TABLE 412 (b) Rear Building Types**

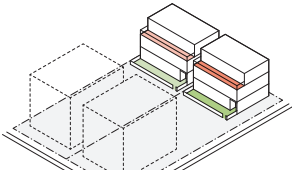
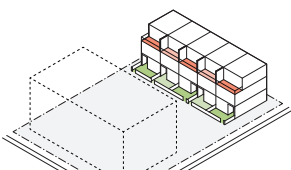
Rear Building Types			
<b>Carriage House</b>	<b>Mews Building</b>		
			

Principal and Rear Building Types

(c) HISTORIC HOUSE

1. Lot Standards (See Sec. 61-11-409 (b))

2. Building Placement (See Sec. 61-11-409 (c))

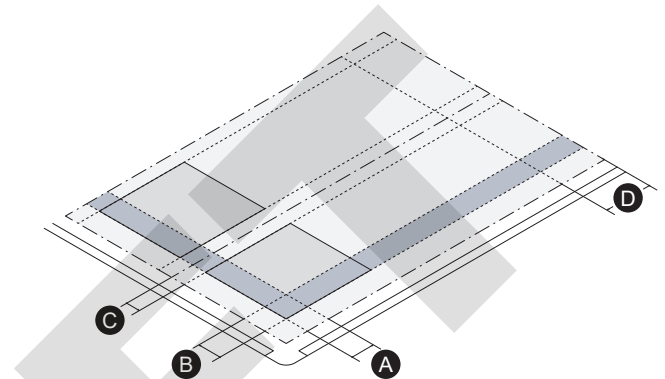
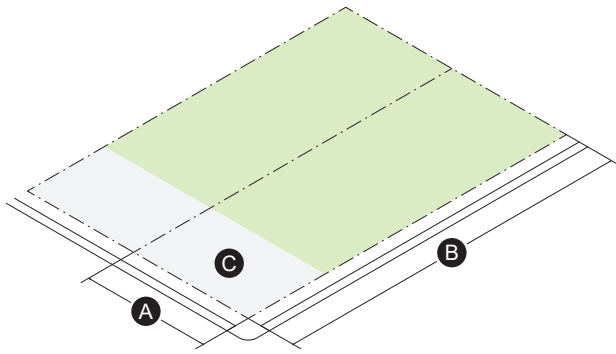

**Frontage**

Required Street Frontage n/a

**Lot Dimensions**

**A** Width 50' min  
**B** Depth 135' min

**Lot Development**

**C** Building Coverage 40% max

**Building Setbacks**

**A** Primary Front Setback<sup>1</sup> 10' min 20' max  
**B** Secondary Front Setback<sup>1</sup> 10' min 20' max  
**C** Side Setback 6' min  
**D** Rear Setback 20' min

<sup>1</sup> See Sec. 61-11-409(c).4 Contextual Front Setbacks

**3. Access/Parking** (See Sec. 61-11-410)

**4. Building Standards** (See Sec. 61-11-409 (d))

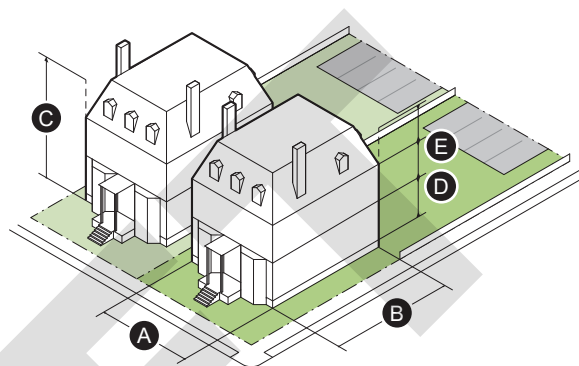
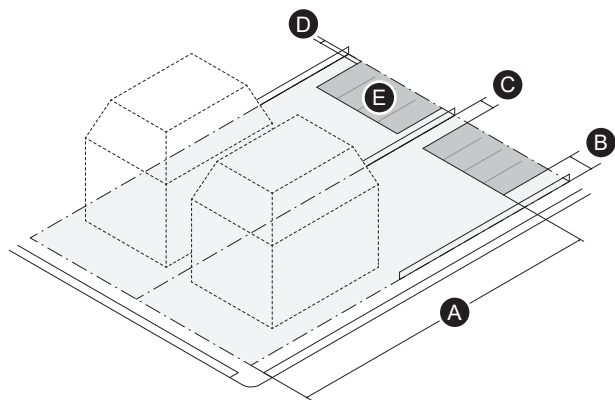

**Parking Setbacks**

<b>A</b> Primary Front Setback	60' min
<b>B</b> Secondary Front Setback	10' min
<b>C</b> Side Setback	5' min
<b>D</b> Rear Setback	0' min

**Parking Ratio**

<b>E</b> Parking Spaces	0.5/DU min
-------------------------	------------

**Parking Access**

Abutting an Alley	Preferred
Primary Frontage	Permitted
Driveway Width	12' max

**Lot Perimeter Definition** (See Sec. 61-11-411)

Side & Rear Fencing or Hedge Row	Required where screening parking
Fence or Hedge Height	4' min 6' max

**Massing**

Facade Build Out	70% min
<b>A</b> Width	35' min 40' max
<b>B</b> Depth	40' min 55' max
<b>C</b> Number of Stories	2.5 max
Story Height	10' min
Ground Floor Elevation	2' min
Building Height, Feet	30' max

**Fenestration**

<b>D</b> Ground Story Fenestration	20% min 50% max
<b>E</b> Upper Story Fenestration	20% min 50% max

**Use & Occupancy**

Outdoor Amenity Space	1/DU min
-----------------------	----------

Principal and Rear Building Types

(d) MULTIPLEX

1. Lot Standards (See Sec. 61-11-409 (b))

2. Building Placement (See Sec. 61-11-409 (c))

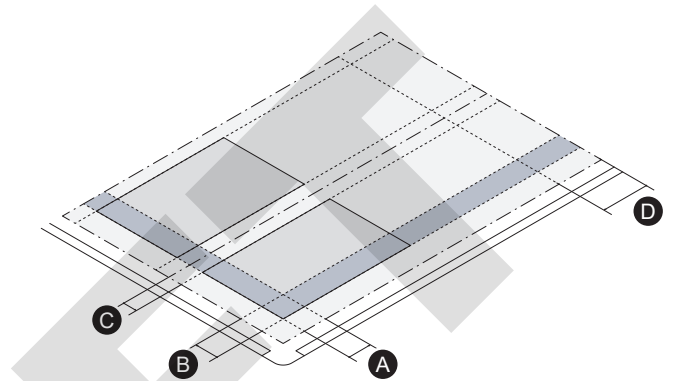
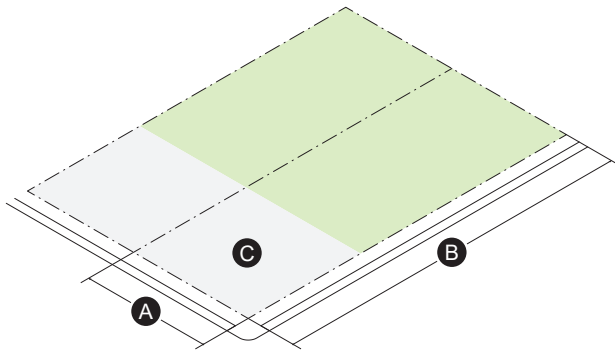

**Frontage**

Required Street Frontage B or C Street

**Lot Dimensions**

A Width 50' min  
 B Depth 135' min

**Lot Development**

C Building Coverage 35% max

**Building Setbacks**

A Primary Front Setback<sup>1</sup> 10' min 20' max  
 B Secondary Front Setback<sup>1</sup> 10' min 20' max  
 C Side Setback 6' min  
 D Rear Setback 20' min

<sup>1</sup> See 61-11-409(c).4 Contextual Front Setbacks

**3. Access/Parking** (See Sec. 61-11-410)

**4. Building Standards** (See Sec. 61-11-409 (d))

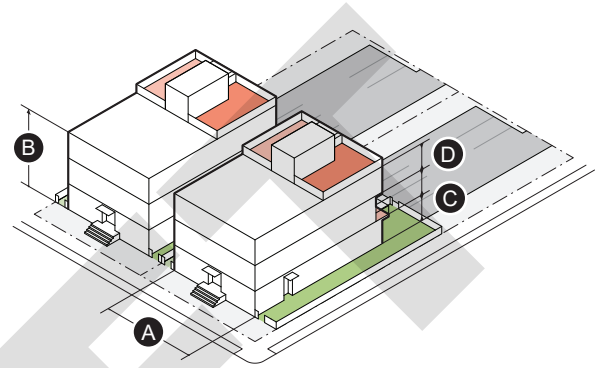
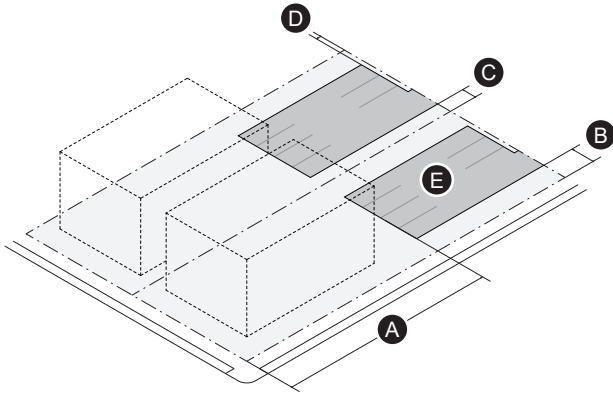

**Parking Setbacks**

<b>A</b> Primary Front Setback	60' min
<b>B</b> Secondary Front Setback	10' min
<b>C</b> Side Setback	5' min
<b>D</b> Rear Setback	0' min

**Parking Ratio**

<b>E</b> Parking Spaces	0.5/DU min
-------------------------	------------

**Parking Access**

Abutting an Alley	Preferred
Primary Frontage	Not Allowed
Secondary Frontage	B or C Street Only
Driveway Width	12' max

**Lot Perimeter Definition** (See Sec. 61-11-411)

Side & Rear Fencing or Hedge Row	Required where screening parking
Fence or Hedge Height	4' min 6' max

**Massing**

Facade Build Out	70% min
<b>A</b> Width	35' min 38' max
<b>B</b> Number of Stories	2 min 3 max
Story Height	10' min
Ground Floor Elevation	2' min
Building Height, Feet	40' max

**Fenestration**

<b>C</b> Ground Story Fenestration	20% min 70% max
<b>D</b> Upper Story Fenestration	20% min 70% max
Blank Wall	20' max

**Use & Occupancy**

Outdoor Amenity Space	1/DU min
-----------------------	----------

Principal and Rear Building Types

(e) TOWNHOUSES

1. Lot Standards (See Sec. 61-11-409 (b))

2. Building Placement (See Sec. 61-11-409 (c))

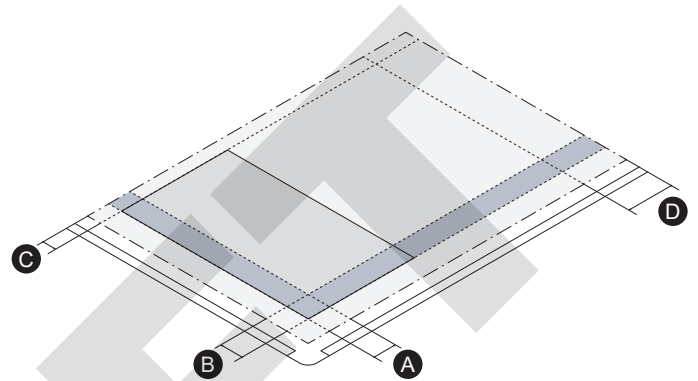
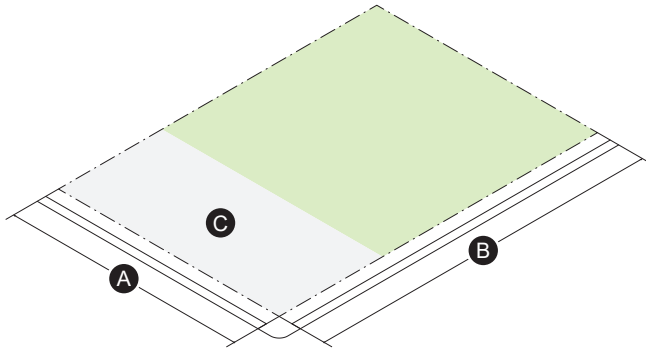

**Frontage**

Required Street Frontage <sup>1</sup>	A, B, or C Street
---------------------------------------	-------------------

**Lot Dimensions**

<b>A</b> Width	50' min
<b>B</b> Depth	--
A Street Frontage	85' min
B or C Street Frontage	135' min

**Lot Development**

<b>C</b> Building Coverage	40% max
----------------------------	---------

<sup>1</sup> See Sec. 61-11-407(b).3 Permissible Building Type

**Building Setbacks**

<b>A</b> Primary Front Setback <sup>2</sup>	--	--
A Street	0' min	3' max
Chrysler Service Dr.	25' min	35' max
B & C Street	10' min	20' max
<b>B</b> Secondary Front Setback <sup>2</sup>	--	--
B & C Street	10' min	20' max
<b>C</b> Side Setback	--	--
Party Lot Line	0' min	
Side Lot Line	6' min	
<b>D</b> Rear Setback	20' min	

<sup>2</sup> See Sec. 61-11-409(c).4 Contextual Front Setbacks



**3. Access/Parking** (See Sec. 61-11-410)

**4. Building Standards** (See Sec. 61-11-409 (d))

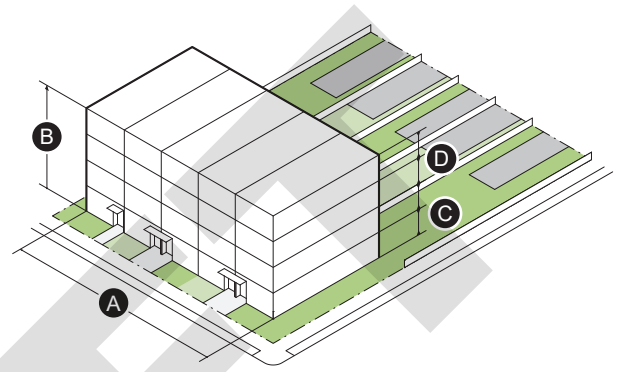
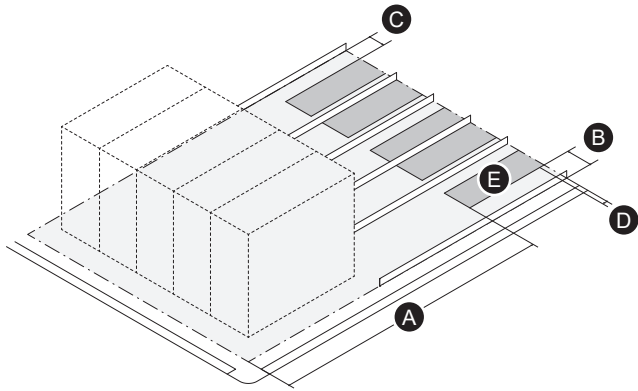

**Parking Setbacks**

<b>A</b> Primary Front Setback	20' min
<b>B</b> Secondary Front Setback	10' min
<b>C</b> Side Setback	5' min
<b>D</b> Rear Setback	0' min

**Parking Ratio**

<b>E</b> Parking Spaces	0.5/DU min
-------------------------	------------

**Parking Access**

Abutting an Alley	Preferred
Primary Frontage	Not Allowed
Secondary Frontage	B or C Street Only
Driveway Width	12' max

**Lot Perimeter Definition** (See Sec. 61-11-411)

Side & Rear Fencing or Hedge Row	Required where screening parking
Fence or Hedge Height	4' min 6' max

**Massing**

Facade Build Out	70% min
<b>A</b> Width	16' min 19' max
<b>B</b> Number of Stories	2 min 4 max
Story Height	10' min
Ground Floor Elevation	2' min
Building Height, Feet	50' max

**Fenestration**

<b>C</b> Ground Story Fenestration	20% min 70% max
<b>D</b> Upper Story Fenestration	20% min 70% max
Blank Wall	20' max

**Use & Occupancy**

Townhouses, Total	2 min 10 max
Outdoor Amenity Space	1/DU min

Principal and Rear Building Types

(f) MID-RISE FLATS

1. Lot Standards (See Sec. 61-11-409 (b))

2. Building Placement (See Sec. 61-11-409 (c))

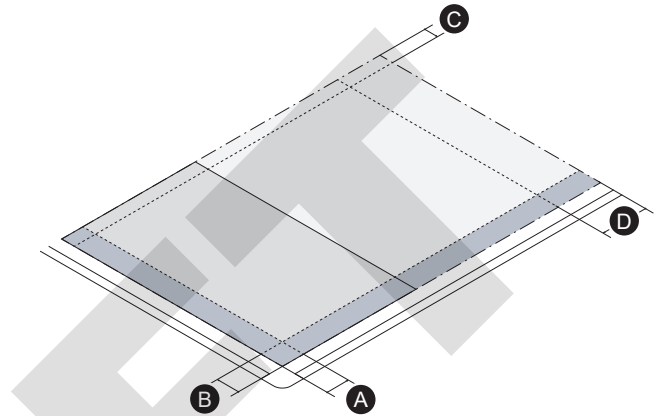
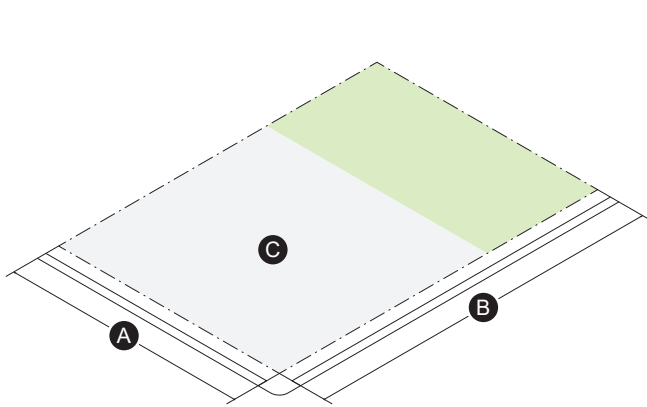

**Frontage**

Required Street Frontage	A or B Street
--------------------------	---------------

**Lot Dimensions**

<b>A</b> Width	50' min
<b>B</b> Depth	85' min

**Lot Development**

<b>C</b> Building Coverage	no max
----------------------------	--------

**Building Setbacks**

<b>A</b> Primary Front Setback <sup>1</sup>	0' min	10' max
Chrysler Service Dr.	25' min	35' max
<b>B</b> Secondary Front Setback <sup>1</sup>	0' min	10' max
<b>C</b> Side Setback	--	
A Street	0' min	
B or C Street	5' min	
<b>D</b> Rear Setback	20' min	

<sup>1</sup> See Sec. 61-11-409(c).4 Contextual Front Setbacks

**3. Access/Parking** (See Sec. 61-11-410)

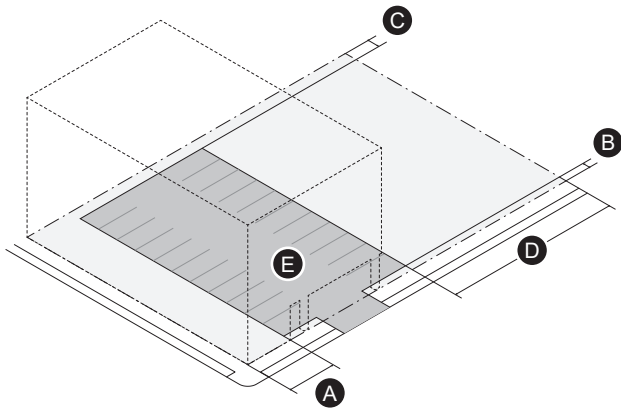

**4. Building Standards** (See Sec. 61-11-409 (d))

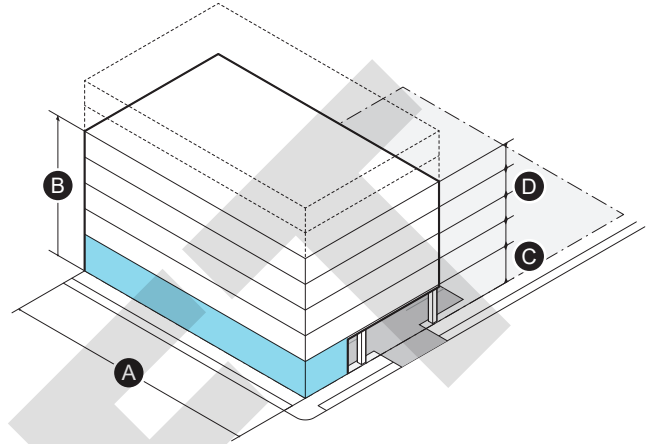

**Parking Setbacks**

<b>A</b> Primary Front Setback	20' min
<b>B</b> Secondary Front Setback	20' min
<b>C</b> Side Setback	0' min
<b>D</b> Rear Setback	0' min

**Parking Ratio**

<b>E</b> Parking Spaces	
Residential	0.5/DU min
Commercial and Other Uses	1.5/1000 sf min
Food and Beverage Service	1.5/500 sf min

**Parking Access**

Abutting an Alley	Preferred
Primary Frontage	Not Allowed
Secondary Frontage	B or C Street Only
Vehicular Entrance Width	24' max

**Perimeter Definition** (See Sec. 61-11-411)

Side & Rear Fencing or Hedge Row	Required where screening parking
Fence or Hedge Height	4' min 6' max

**Massing**

Facade Build Out	80% min
<b>A</b> Width	30' min 200' max
<b>B</b> Number of Stories <sup>2</sup>	7 max
Ground Story Height	14' min
Upper Story Height	10' min
Building Height, Feet	80' max

<sup>2</sup> See Sec. 61-11-409(d).7 Contextual Height and 61-11-409(d).8 Additional Story Allowance

**Fenestration**

<b>C</b> Ground Story Fenestration	--
Residential	20% min 70% max
Commercial	70% min
<b>D</b> Upper Story Fenestration	20% min 70% max
Blank Wall	20' max

**Use & Occupancy**

Outdoor Amenity Space	1/DU min
-----------------------	----------

Principal and Rear Building Types

(g) CARRIAGE HOUSE

1. Lot Standards (See Sec. 61-11-409 (b))

2. Building Placement (See Sec. 61-11-409 (c))

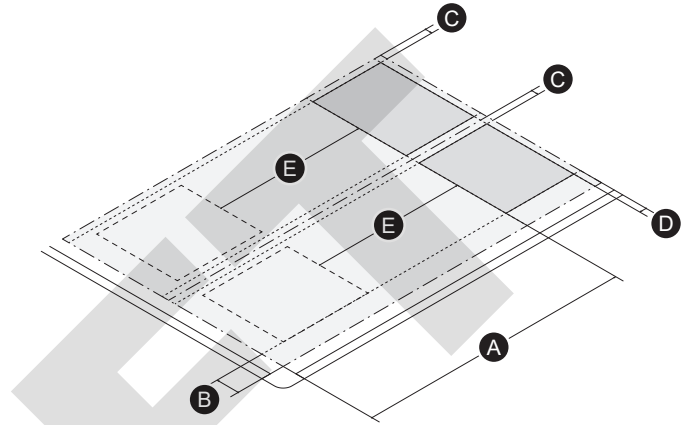
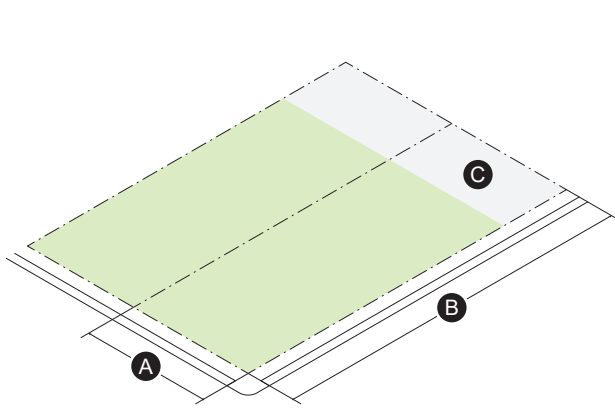

**Frontage**

Required Street Frontage      A, B, or C Street

**Lot Dimensions**

**A** Width      50' min  
**B** Depth      135' min

**Lot Development**

**C** Building Coverage      20% max

**Building Setbacks**

**A** Primary Front Setback      60' min  
**B** Secondary Front Setback      10' min  
**C** Side Setback      3' min  
**D** Rear Setback      0' min  
**E** Separation from Principal Building      10' min

**3. Access/Parking** (See Sec. 61-11-410)

**4. Building Standards** (See Sec. 61-11-409 (d))

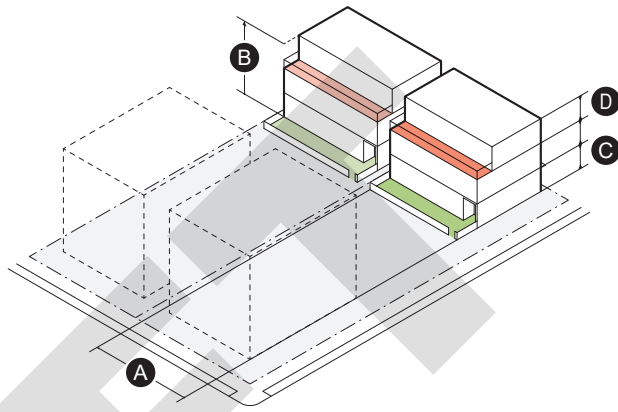
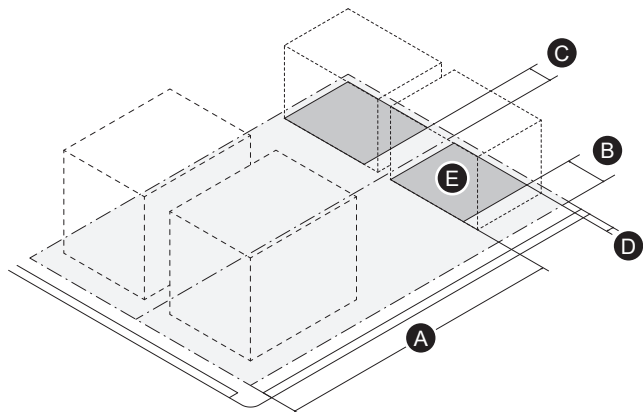

**Parking Setbacks**

<b>A</b> Primary Front Setback	60' min
<b>B</b> Secondary Front Setback	10' min
<b>C</b> Side Setback	5' min
<b>D</b> Rear Setback	0' min

**Parking Ratio**

<b>E</b> Parking Spaces	0.5/DU min
-------------------------	------------

**Parking Access**

Abutting an Alley	Required
Primary Frontage	Not Allowed

**Perimeter Definition**

Side & Rear Fencing or Hedge Row	Optional
Fence or Hedge Height	4' min 6' max

**Massing**

Facade Build Out	45% min
<b>A</b> Width	24' min 36' max
<b>B</b> Number of Stories	1 min 3 max
Story Height	10' min
Ground Floor Elevation	0' min
3rd Story Stepback	6' min
Building Height, Feet	35' max

**Fenestration**

<b>C</b> Ground Story Fenestration	15% min 50% max
<b>D</b> Upper Story Fenestration	15% min 50% max
Blank Wall	30' max

**Use & Occupancy**

Outdoor Amenity Space	1/DU min
-----------------------	----------

Principal and Rear Building Types

(h) MEWS BUILDING

1. Lot Standards (See Sec. 61-11-409 (b))

2. Building Placement (See Sec. 61-11-409 (c))

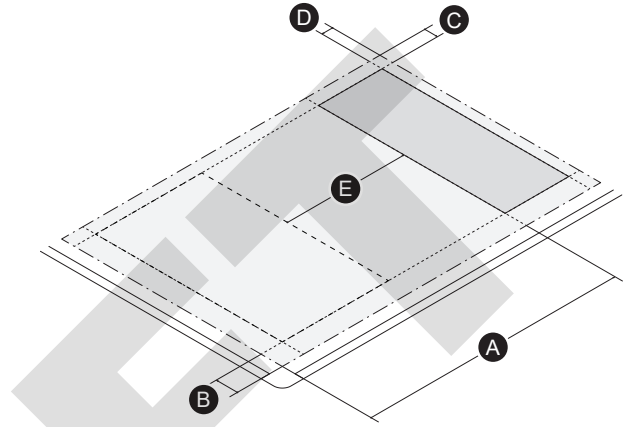
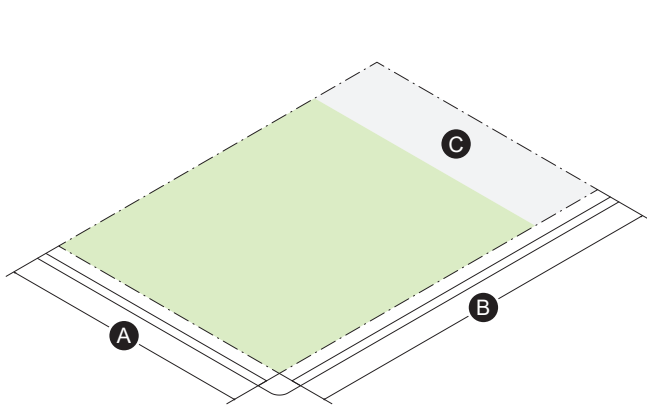

**Frontage**

Required Street Frontage A, B, or C Street

**Lot Dimensions**

- A** Width 100' min
- B** Depth 135' min

**Lot Development**

- C** Building Coverage 20% max

**Building Setbacks**

- A** Primary Front Setback 60' min
- B** Secondary Front Setback 10' min
- C** Side Setback 3' min
- D** Rear Setback 0' min
- E** Separation from Principal Building 10' min

4. Access/Parking (See Sec. 61-11-410)

3. Building Standards (See Sec. 61-11-409 (d))

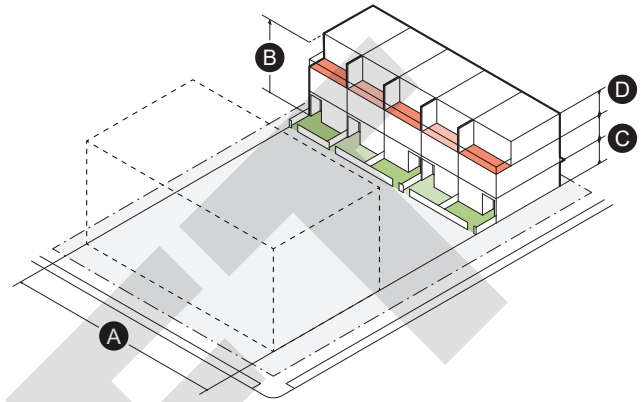
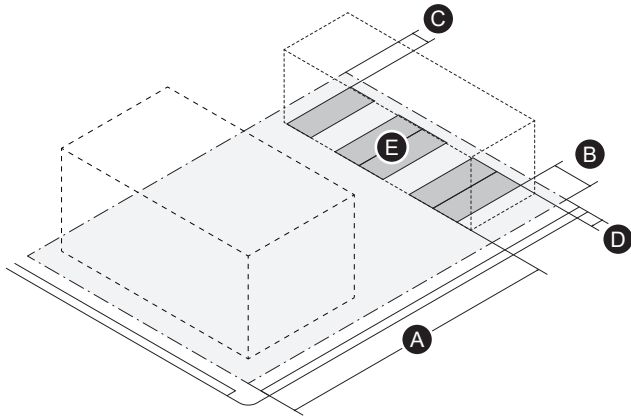

**Parking Setbacks**

<b>A</b> Primary Front Setback	60' min
<b>B</b> Secondary Front Setback	10' min
<b>C</b> Side Setback	5' min
<b>D</b> Rear Setback	0' min

**Parking Ratio**

<b>E</b> Parking Spaces	0.5/DU min
-------------------------	------------

**Parking Access**

Abutting an Alley	Required
Primary Frontage	Not Allowed

**Perimeter Definition**

Side & Rear Fencing or Hedge Row	Optional
Fence or Hedge Height	4' min 6' max

**Massing**

Facade Build Out	80% min
<b>A</b> Width	35' min 84' max
<b>B</b> Number of Stories	2 min 3 max
Story Height	10' min
Ground Floor Elevation	0' min
3rd Story Stepback	6' min
Building Height, Feet	35' max

**Fenestration**

<b>C</b> Ground Story Fenestration	15% min 50% max
<b>D</b> Upper Story Fenestration	15% min 50% max
Blank Wall	30' max

**Use & Occupancy**

Outdoor Amenity Space	1/DU min
-----------------------	----------

Use Standards

**SEC. 61-11-413 USE STANDARDS**

**(a) General**

1. The use of zoning lots within the District is subject to the provisions of ARTICLE XII. USE REGULATIONS of this Ordinance. Where the provisions of this section conflict with those of ARTICLE XII, the provisions of this Division apply.
2. Uses are permitted according to Table 413. Use categories and specific use types not expressly authorized are prohibited.

**(b) Use Categories**

All of the use categories listed on Table 413 are described in ARTICLE XVI of this Chapter. In some cases, “Specific Use Types” are listed under the broader Use Category. The specific use types and categories are mutually exclusive. Where a Specific Use Type is listed in the table, that use type is allowed only within a building type fronting the street type indicated.

**(c) Understanding the Use Table**

1. Categorization System; use categories and specific use types are identified in the first column of Table 413 and are separated by headings for organizational purposes.
2. Street Types are identified by name in the top row of Table 413.
3. Uses permitted by right; An “R” in the use table indicates that a use category or specific land use is allowed as a matter-of-right for the respective street type, subject to compliance with all other applicable regulations of this Chapter.
4. Uses not allowed; An “N” in the use table indicates that a use type is not allowed for the respective street type.
5. Use specific standards; letters or numbers in the final column of the Use Table indicate that the listed use is subject to use-specific regulations for building types fronting one (1) or more of the street types where the use is allowed. The letters or numbers listed provide a cross-reference to the use-specific regulations, which can be found in ARTICLE XII: DIVISION 2 and DIVISION 3 of this Chapter.

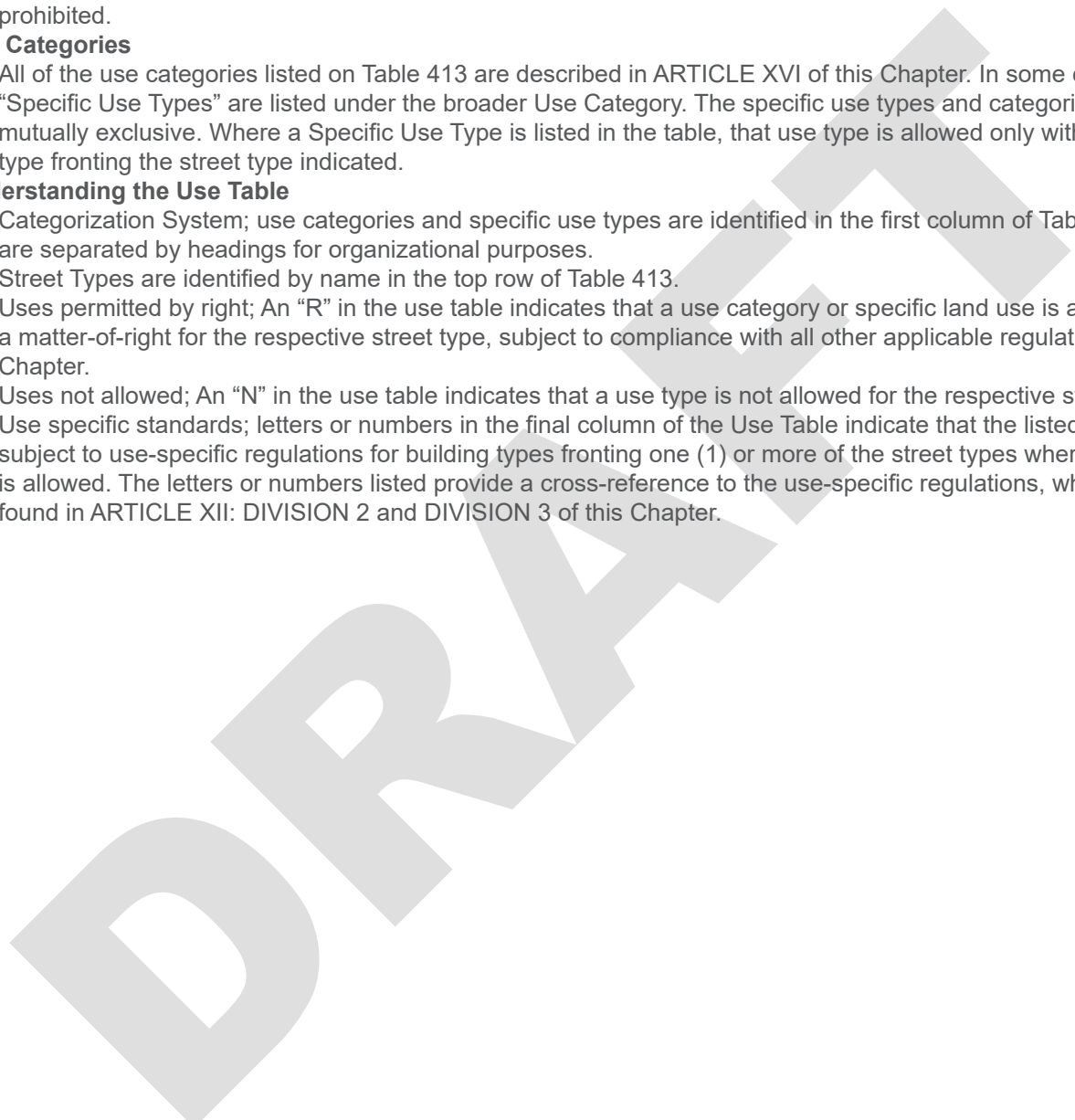



TABLE 413 Permitted Uses

Use Category Specific Use Type	Street Designation			Standards General (Art. XII, Div. 2) Standards Specific (Art. XII, Div. 3)
	A-Street	B-Street	C-Street	
<b>Residential Uses</b>				
Household Living				
Loft	R	R	R	Sec. 61-12-117; Sec. 61-12-118
Multi-family dwelling	R	R	R	Sec. 61-12-117; Sec. 61-12-120; Sec. 61-12-121
Single family detached	N	Historic House Only	Historic House Only	Sec. 61-12-117; Sec. 61-12-118
Town house	R	R	R	Sec. 61-12-117; Sec. 61-12-126
Two-family dwelling	N	R	R	Sec. 61-12-117; Sec. 61-12-118
<b>Public, Civic, and Institutional Uses</b>				
Community Service				
Fire or police station, post office, courthouse, and similar public building	R	N	N	Sec. 61-12-136
Neighborhood center, nonprofit	R	R	R	Sec. 61-12-138
Day Care				
Adult day care center	R	R	R	Sec. 61-12-131
Child care center	R	R	R	Sec. 61-12-133; Sec. 61-12-402
Family day care home	R	R	R	Sec. 61-12-135
Library	R	R	N	
Museum	R	R	N	
Outdoor art exhibition grounds; sculpture gardens	R	R	R	
<b>Park &amp; Open Space</b>				
Outdoor recreation facility	R	R	R	Sec. 61-12-139; Sec. 61-13-131(4)
<b>Religious Institution</b>				
All	R	R	R	
<b>Schools</b>				
Educational institution	R	R	R	Sec. 61-12-134
School, elem, middle/junior high, or high	R	R	N	Sec. 61-12-139.5
<b>Retail, Service and Commercial Uses</b>				
Assembly				

R - By-Right    N - Not Permitted

Use Standards

**TABLE 413 Permitted Uses**

Use Category Specific Use Type	Street Designation			Standards General (Art. XII, Div. 2) Standards Specific (Art. XII, Div. 3)
	A-Street	B-Street	C-Street	
Private club, lodge, or similar use	R	R	N	Sec. 61-12-224
Rental hall or banquet hall	R	R	N	
<b>Food and Beverage Service</b>				
Brewpub or microbrewery or small distillery	R	N	N	Sec. 61-12-158
Establishment for the sale of alcoholic beverages for consumption on the premises	R	N	N	Sec. 61-12-161
Restaurant, carry-out, without drive-up	R	R	N	SPC; Sec. 61-12-228; Sec. 61-12-401
Restaurant, fast-food, without drive-up	R	R	N	SPC; Sec. 61-12-228; Sec. 61-12-401
Restaurant, standard, without drive-up	R	R	N	SPC; Sec. 61-12-229; Sec. 61-12-401
<b>Office</b>				
Medical or dental clinic, physical therapy clinic, or massage therapy clinic	R	R	R	Sec. 61-12-173
Office, business or professional	R	R	R	Sec. 61-12-218
Radio or television station	R	R	N	
Recording studio or photo studio or video studio, no assembly hall	R	R	N	
<b>Public Accommodation</b>				
Bed and breakfast inn	R	R	R	Sec. 61-12-157
Hotel	R	R	R	Sec. 61-12-169; Sec. 61-12-231; Sec. 61-12-404
Youth hostel/hostel	R	R	R	Sec. 61-12-241
<b>Recreation/entertainment, indoor</b>				
Arcade	R	R	N	CU; P; SPC; Sec. 61-12-154; Sec. 61-12-405

R - By-Right    N - Not Permitted

**TABLE 413 Permitted Uses**

Use Category Specific Use Type	Street Designation			Standards General (Art. XII, Div. 2) Standards Specific (Art. XII, Div. 3)
	A-Street	B-Street	C-Street	
Pool or billiard hall	R	R	N	CU; P; SPC; Sec. 61-12-223
Recreation, indoor comm. and health club	R	R	R	Sec. 61-12-226
Theater & Concert café, excluding drive-in theaters	R	N	N	<150 seats; Sec. 61-12-238
<b>Retail sales and service; sales oriented</b>				
Stores of a generally recognized retail nature whose primary business is the sale of new merchandise	R	R	R	
Art gallery	R	R	R	
Bake shop, retail	R	R	R	Sec. 61-12-156
Pet shop	R	R	N	Sec. 61-12-222
Produce or food markets, wholesale	R	N	N	
Secondhand stores and secondhand jewelry stores	R	R	N	RU; SPC; Sec. 61-12-233
Specially designated distributor's (SDD) or specially designated merchant's (SDM) establishment	R	R	N	CU; P; SPC; Sec. 61-12-234
<b>Retail sales and service; service oriented</b>				
Animal-grooming shop	R	R	R	Sec. 61-12-153
Automated teller machine, without drive-up	R	N	N	
Bank without drive-up	R	R	N	
Barber or beauty shop	R	R	R	Sec. 61-12-408
Business college or commercial trade school	R	N	N	Sec. 61-12-239
Dry cleaning, laundry, or laundromat	R	R	R	Sec. 61-12-162
Kennel, commercial	R	N	N	Sec. 61-12-170
Nail salon	R	R	R	

R - By-Right    N - Not Permitted

Use Standards

**TABLE 413 Permitted Uses**

Use Category Specific Use Type	Street Designation			Standards General (Art. XII, Div. 2) Standards Specific (Art. XII, Div. 3)
	A-Street	B-Street	C-Street	
Printing or engraving shops	R	R	R	Sec. 61-12-242
Radio, television, or household appliance repair shop	R	R	N	
School or studio of dance, gymnastics, music, art, or cooking	R	R	R	Sec. 61-12-232
Shoe repair shop	R	R	R	Sec. 61-12-408
Tattoo and/or piercing parlor	R	R	N	Sec. 61-12-236
Veterinary clinic for small animals	R	R	N	Sec. 61-12-240
<b>Manufacturing and Industrial Uses</b>				
General: Low/medium-impact manufacturing or processing as defined in Sec. 61-16-124	R	R	R	Sec. 61-12-283; Sec. 61-12-368
General: Low-impact manufacturing or processing as defined in Sec. 61-16-124	R	R	R	Sec. 61-12-281; Sec. 61-12-368
Confection manufacture	R	R	R	Sec. 61-12-254; Sec. 61-12-368
Food catering establishment	R	R	R	Sec. 61-12-255.5; Sec. 61-12-368
Jewelry manufacture	R	R	R	Sec. 61-12-260; Sec. 61-12-368
Lithographing, and sign shops	R	R	N	Sec. 61-12-262; Sec. 61-12-368
Wearing apparel manufacturing	R	R	R	Sec. 61-12-282; Sec. 61-12-368
<b>Agricultural Uses</b>				
Aquaculture	R	R	R	
Aquaponics	R	R	R	
Hydroponics	R	R	R	
Urban garden	N	N	R <0.5 acre	

R - By-Right    N - Not Permitted